



STAIRVILLE

maTrixx SC-100 DMX
LED Effect
LED scanner

Thomann GmbH

Hans-Thomann-Straße 1

96138 Burgebrach

Germany

Telephone: +49 (0) 9546 9223-0

Internet: www.thomann.de

01.02.2022, ID: 119950 (V2)

Table of contents

1	General information	5
	1.1 Further information.....	6
	1.2 Notational conventions.....	7
	1.3 Symbols and signal words.....	7
2	Safety instructions	10
3	Features	14
4	Installation	15
5	Starting up	19
6	Connections and controls	22
7	Operating	24
	7.1 Starting the device.....	24
	7.2 Operating mode 'Master / Slave'.....	27
	7.3 Operating mode 'Sound to Light'.....	28
	7.4 Operating mode 'DMX'.....	28
	7.5 Remote control functions.....	31

8	Technical specifications.....	33
9	Plug and connection assignments.....	36
10	Troubleshooting.....	37
11	Cleaning.....	39
12	Protecting the environment.....	40

1 General information

This user manual contains important information on the safe operation of the device. Read and follow all safety notes and all instructions. Save this manual for future reference. Make sure that it is available to all persons using this device. If you sell the device to another user, be sure that they also receive this manual.

Our products and user manuals are subject to a process of continuous development. We therefore reserve the right to make changes without notice. Please refer to the latest version of the user manual which is ready for download under www.thomann.de.

1.1 Further information

On our website (www.thomann.de) you will find lots of further information and details on the following points:

Download	This manual is also available as PDF file for you to download.
Keyword search	Use the search function in the electronic version to find the topics of interest for you quickly.
Online guides	Our online guides provide detailed information on technical basics and terms.
Personal consultation	For personal consultation please contact our technical hotline.
Service	If you have any problems with the device the customer service will gladly assist you.

1.2 Notational conventions

This manual uses the following notational conventions:

Letterings



The letterings for connectors and controls are marked by square brackets and italics.

Examples: *[VOLUME]* control, *[Mono]* button.

1.3 Symbols and signal words

In this section you will find an overview of the meaning of symbols and signal words that are used in this manual.

Signal word	Meaning
DANGER!	This combination of symbol and signal word indicates an immediate dangerous situation that will result in death or serious injury if it is not avoided.
WARNING!	This combination of symbol and signal word indicates a possible dangerous situation that can result in death or serious injury if it is not avoided.
CAUTION!	This combination of symbol and signal word indicates a possible dangerous situation that can result in minor injury if it is not avoided.
NOTICE!	This combination of symbol and signal word indicates a possible dangerous situation that can result in material and environmental damage if it is not avoided.
Warning signs	Type of danger
	Warning – high-voltage.

Warning signs	Type of danger
	<p>Warning – dangerous optical radiation.</p>
	<p>Warning – suspended load.</p>
	<p>Warning – danger zone.</p>

2 Safety instructions

Intended use

This device is intended for use as a multifunctional lighting instrument with movable mirror. The device is designed for professional use only and is not suitable for use in households. Use the device only as described in this user manual. Any other use or use under other operating conditions is considered to be improper and may result in personal injury or property damage. No liability will be assumed for damages resulting from improper use.

This device may be used only by persons with sufficient physical, sensorial, and intellectual abilities and having corresponding knowledge and experience. Other persons may use this device only if they are supervised or instructed by a person who is responsible for their safety.



Extend the operating life of the device by regular breaks and by avoiding frequent switching on and off. The device is not suitable for continuous operation.

Safety**DANGER!****Danger for children**

Ensure that plastic bags, packaging, etc. are disposed of properly and are not within reach of babies and young children. Choking hazard! Ensure that children do not detach any small parts (e.g. knobs or the like) from the unit. They could swallow the pieces and choke! Never let children unattended use electrical devices.

**DANGER!****Electric shock caused by high voltages inside**

Within the device there are areas where high voltages may be present. Never remove any covers. There are no user-serviceable parts inside. Do not use the device if covers, protectors or optical components are missing or damaged.

**DANGER!****Electric shock caused by short-circuit**

Always use proper ready-made insulated mains cabling (power cord) with a protective contact plug. Do not modify the mains cable or the plug. Failure to do so could result in electric shock/death or fire. If in doubt, seek advice from a registered electrician.

**WARNING!****Eye damage caused by high light intensity**

The lamp used in this device produces an intense beam of visible and invisible light radiation. Do not start the operation of the device without completely fixed covers. Never look directly into the light source.



WARNING!

Risk of epileptic shock

Strobe lighting can trigger seizures in photosensitive epilepsy. Sensitive persons should avoid looking at strobe lights.



CAUTION!

Risk of injury due to mirror movements

The mirror mounted at the device head may perform very fast movements (pan, tilt) and reflect very bright light. This is also the case immediately after switching on the device, with automatic or remote operation, and while a connected DMX controller is in off state. Persons who are in the immediate vicinity of the device may be injured or frightened by this. Make sure that there are no obstacles within the movement range of the mirror, and that no persons are in the immediate vicinity of the device before switching it on and during its operation. If any work is to be carried out within the movement range or in the immediate vicinity of the mirror, the device must remain switched off.



NOTICE!

Risk of fire

Do not block areas of ventilation. Do not install the device near any direct heat source. Keep the device away from naked flames.

**NOTICE!****Operating conditions**

This device has been designed for indoor use only. To prevent damage, never expose the device to any liquid or moisture. Avoid direct sunlight, heavy dirt, and strong vibrations. Only operate the device within the ambient conditions specified in the chapter 'Technical specifications' of this user manual. Avoid heavy temperature fluctuations and do not switch the device on immediately after it was exposed to temperature fluctuations (for example after transport at low outside temperatures). Dust and dirt inside can damage the unit. When operated in harmful ambient conditions (dust, smoke, nicotine, fog, etc.), the unit should be maintained by qualified service personnel at regular intervals to prevent overheating and other malfunction.

**NOTICE!****Power supply**

Before connecting the device, ensure that the input voltage (AC outlet) matches the voltage rating of the device and that the AC outlet is protected by a residual current circuit breaker. Failure to do so could result in damage to the device and possibly injure the user. Unplug the device before electrical storms occur and when it is unused for long periods of time to reduce the risk of electric shock or fire.

**NOTICE!****Possible damage due to installation of a wrong fuse**

The use of different types of fuses can cause serious damage to the unit. Fire hazard! Only fuses of the same type may be used.

3 Features

The LED scanner is especially suited for professional lighting tasks, e.g. during events, on rock music stages, in theatre and musical productions or in discotheques.

Special features of the device:

- LED matrix (16 × red, 12 × green, 12 × blue, 12 × white)
- Control via DMX (4 channels) or via optionally available wired remote)
- Built-in automatic show programmes
- Sound control
- Master / slave mode
- Shutter for strobe effect

For technological reasons, the light output of LEDs decreases over their lifetime. This effect increases with higher operating temperature. You can extend the service life of the illuminants by providing adequate ventilation and operating the LEDs with the lowest possible brightness.

4 Installation

Unpack and check carefully there is no transportation damage before using the unit. Keep the equipment packaging. To fully protect the product against vibration, dust and moisture during transportation or storage use the original packaging or your own packaging material suitable for transport or storage, respectively.



WARNING!

Risk of injury caused by falling objects

Make sure that the installation complies with the standards and rules that apply in your country. Always secure the device with a secondary safety attachment, such as a safety cable or a safety chain.



NOTICE!

Risk of overheating

The distance between light output and the illuminated surface must be more than 1.5 m (19.7in).

Provide sufficient ventilation.

The ambient temperature must always be below 40 °C (104 °F).



NOTICE!

Use of stands

When mounting the device onto a stand, ensure that the stand is in a safe and stable position and that the weight of the device does not exceed the maximum permissible load capacity of the stand.

**NOTICE!****Possible data transmission errors**

For error-free operation make use of dedicated DMX cables and do not use ordinary microphone cables.

Never connect the DMX input or output to audio devices such as mixers or amplifiers.

Mounting options

You can install the unit in hanging or standing position. When in use, the device must always be attached to a solid surface or an approved truss. Use the openings of the bracket provided for mounting.

Always work from a stable platform whenever installing, moving or servicing the unit. In doing so, the area underneath the unit must be cordoned off.

The safety cable must be attached to the bracket.



Please note that this device must not be connected to a dimmer.

5 Starting up

Create all connections while the device is off. Use the shortest possible high-quality cables for all connections. Take care when running the cables to prevent tripping hazards.

Connections in DMX mode

Connect the DMX input of the device to the DMX output of a DMX controller or another DMX device. Connect the output of the first DMX device to the input of the second one, and so on to form a daisy chain. Always ensure that the output of the last DMX device in the daisy chain is terminated with a resistor (110Ω , $\frac{1}{4} \text{ W}$).

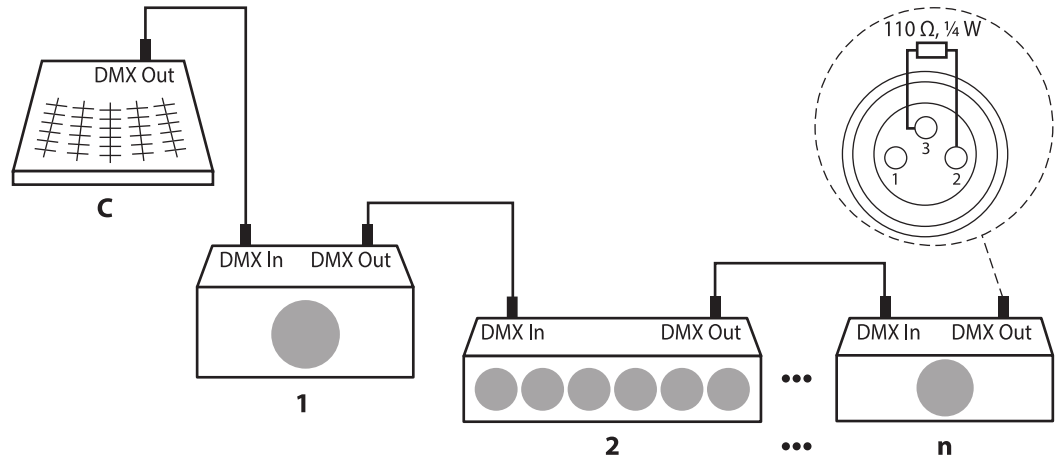

Connections in master/slave mode

When you configure a group of devices in master/slave mode, the first unit will control the other units for an automatic, sound-activated, synchronized show. This function is ideal when you want to start a show immediately. Connect the DMX output of the master device to the DMX input of the first slave device. Then connect the DMX output of the first slave device to the DMX input of the second slave device and so on.

6 Connections and controls

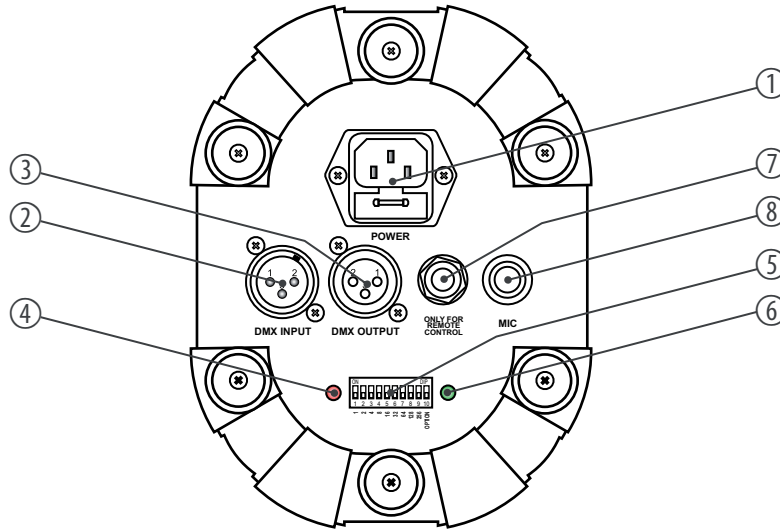

1	<i>[POWER]</i> IEC chassis plug for power supply with fuse holder
2	<i>[DMX INPUT]</i> DMX input
3	<i>[DMX OUTPUT]</i> DMX output
4	Indicator LED. Indicates that the device is connected to the power supply.
5	<i>[START ADDRESS SELECT]</i> DIP switch for setting the DMX address and for inverting the preprogrammed automatic show.
6	Indicator LED for the operating mode and DMX connection. The LED lights up when the unit is operating in stand-alone mode, the LED flashes when a DMX signal is received.
7	<i>[ONLY FOR REMOTE CONTROL]</i> 1/4" phone socket for connecting the optionally available remote control Stairville Pocket Master
8	<i>[MIC]</i> Microphone for sound control

7 Operating

7.1 Starting the device



CAUTION!

Risk of injury due to mirror movements

The mirror mounted at the device head may perform very fast movements (pan, tilt) and reflect very bright light. This is also the case immediately after switching on the device, with automatic or remote operation, and while a connected DMX controller is in off state. Persons who are in the immediate vicinity of the device may be injured or frightened by this.

Make sure that there are no obstacles within the movement range of the mirror, and that no persons are in the immediate vicinity of the device before switching it on and during its operation. If any work is to be carried out within the movement range or in the immediate vicinity of the mirror, the device must remain switched off.

Connect the device to the power supply to start operation. After a few seconds, the fans start to work, the mirror at the device head moves to the home positions for rotation (Pan) and inclination (Tilt).

Setting up the DMX address

The value of the DIP switches 1-9 is binary coded. To set the desired DMX address, set the DIP switches so that the sum of the resulting numbers yields the desired DMX address. Please orient yourself by the following table:

SW9	SW8	SW7	SW6	SW5	SW4	SW3	SW2	SW1	DMX address
0	0	0	0	0	0	0	0	1	1
0	0	0	0	0	0	0	1	0	2
0	0	0	0	0	0	1	0	0	4
0	0	0	0	0	1	0	0	0	8
0	0	0	0	1	0	0	0	0	16
0	0	0	1	0	0	0	0	0	32
0	0	1	0	0	0	0	0	0	64
0	1	0	0	0	0	0	0	0	128
1	0	0	0	0	0	0	0	0	256

0: DIP switch is in 'OFF' position. 1: DIP switch is in 'ON' position.

Example: To set the DMX address 10 set DIP switches 2 and 4 to 'ON', all others to 'OFF'. The highest possible DMX address is 511 (all DIP switches to 'ON').

7.2 Operating mode 'Master / Slave'

Connect the required devices in a chain. The DMX address of the first device (working as 'master') must be set to 001 (first DIP switch set to 'ON', all the others to 'OFF'). The other devices (which are set up as 'slave'), may be set to any DMX address except 1.

DIP switch 10 is used to invert the auto show of the devices connected as 'slave'. Set DIP switch 10 to 'ON' to enable this feature.

7.3 Operating mode 'Sound to Light'

In 'Sound to Light' mode (Sound-control), the device responds to the acoustic signals which are received via the built-in microphone.

To enable the mode set DIP switch 1 to 'ON'.

7.4 Operating mode 'DMX'

Functions

Channel	Value	Function
1	0...255	Rotation (Pan)
2	0...255	Inclination (Tilt)
3	Patterns and shows	
	0 ... 9	Blackout
	10 ... 19	Pattern 1

Channel	Value	Function
	20 ... 29	Pattern 2
	30 ... 39	Pattern 3
	40 ... 49	Pattern 4
	50 ... 59	Pattern 5
	60 ... 69	Pattern 6
	70 ... 79	Pattern 7
	80 ... 89	Pattern 8
	90 ... 99	Pattern 9
	100 ... 109	Pattern 10
	110 ... 119	Pattern 11
	120 ... 129	Pattern 12
	130 ... 139	Pattern 13
	140 ... 149	Pattern 14

Channel	Value	Function
	150 ... 159	Pattern 15
	160 ... 169	Automatic show 1
	170 ... 179	Automatic show 2
	180 ... 189	Automatic show 3
	190 ... 199	Automatic show 4
	200 ... 209	Automatic show 5
	210 ... 219	Automatic show 6
	220 ... 229	Automatic show 7
	230 ... 239	Automatic show 8
	240 ... 249	Automatic show 9
	250 ... 255	Automatic show 10
4	Shutter	
	0 ... 9	Closed (blackout)

Channel	Value	Function
	10 ... 249	Strobe effect with increasing speed
	250 ... 255	Switch to sound-control (stand-alone mode without DMX control)

7.5 Remote control functions

The optionally available remote control can only be used when the unit is not controlled via DMX.

If you want to control a master / slave configuration, connect the remote to the 'Master'.

Button	Function
[STANDBY]	Blackout
[FUNCTION]	Depending on the operation mode, selection of a strobe effect, a pattern or a show
[MODE]	Operating mode selection: <ul style="list-style-type: none">■ Sound-control (LED off), selecting a strobe effect with [FUNCTION]■ Pattern (LED on), selecting the pattern with [FUNCTION]■ Automatic show (LED flashing), selecting the show with [FUNCTION]

8 Technical specifications

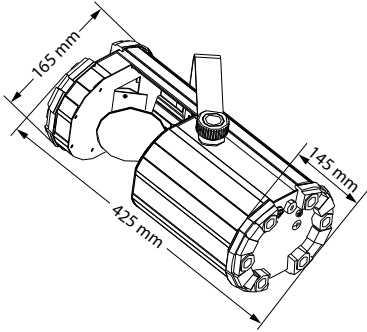

Light source	LED matrix (16 × red, 12 × green, 12 × blue, 12 × white)	
Optical properties	Beam angle	21°
Control	DMX, wired remote control	
Number of DMX channels	4	
Input connections	Power supply	IEC chassis plug C14
	DMX control	XLR chassis socket, 3-pin
	Remote control	1/4" jack socket
Output connections	Power supply of further devices	IEC chassis plug C13
	DMX control	XLR chassis socket, 3-pin
Power consumption	40 W	
Supply voltage	AC 230 V ~ , 50 Hz	

Fuse	5 mm × 20 mm, 2 A, 250 V, slow-blow	
Degree of protection	IP20	
Mounting options	Hanging, standing	
Dimensions (W × H × D)	145 mm × 165 mm × 425 mm	
Weight	3.1 kg	
Ambient conditions	Temperature range	0 °C...40 °C
	Relative humidity	20 %...80 % (non-condensing)

Further information

Similar design	Scan
DMX control	Yes
Master/Slave	Yes
Remote control	Not possible
Sound control	Yes
Display	No

9 Plug and connection assignments

Introduction

This chapter will help you select the right cables and plugs to connect your valuable equipment so that a perfect light experience is guaranteed.

Please take our tips, because especially in 'Sound & Light' caution is indicated: Even if a plug fits into a socket, the result of an incorrect connection may be a destroyed DMX controller, a short circuit or 'just' a not working light show!

DMX connections



The unit offers a 3-pin XLR socket for DMX output and a 3-pin XLR plug for DMX input. Please refer to the drawing and table below for the pin assignment of a suitable XLR plug.

Pin	Configuration
1	Ground, shielding
2	Signal inverted (DMX-, 'cold signal')
3	Signal (DMX+, 'hot signal')

10 Troubleshooting



NOTICE!

Possible data transmission errors

For error-free operation make use of dedicated DMX cables and do not use ordinary microphone cables.

Never connect the DMX input or output to audio devices such as mixers or amplifiers.

In the following we list a few common problems that may occur during operation. We give you some suggestions for easy troubleshooting:

Symptom	Remedy
The unit does not work, no light, the fan does not run	Check the mains connection and the main fuse.
No response to the DMX controller	1. The green LED should flash during data transmission. If it doesn't, check the DMX connectors and cables for proper connection.
	2. If the green LED flashes and there is no response, check the address settings and DMX polarity.
	3. Try using another DMX controller.
	4. Check whether the DMX cables run near or parallel to high-voltage cables that may cause damage or interference to a DMX interface circuit.

If the procedures recommended above do not succeed, please contact our Service Center. You can find the contact information at www.thomann.de.

11 Cleaning

Optical lenses and mirrors

Clean the optical lenses and mirrors which are accessible from the outside periodically to optimise light output. The frequency of cleaning depends on the operating environment: wet, smoky or particularly dirty surroundings can cause more accumulation of dirt on the optics of the device.

- Clean with a soft cloth using our lamp and lens cleaner (item no. 280122).
- Always dry the parts carefully.

Fan grids

The fan grids of the device must be cleaned of any contamination, such as dust, etc. on a regular basis. Before cleaning, switch off the device and disconnect mains-operated devices from the mains. Only use pH-neutral, solvent-free and non-abrasive cleaning agents. Clean the unit with a slightly damp lint-free cloth.

12 Protecting the environment

Disposal of the packaging material



For the transport and protective packaging, environmentally friendly materials have been chosen that can be supplied to normal recycling.

Ensure that plastic bags, packaging, etc. are properly disposed of.

Do not just dispose of these materials with your normal household waste, but make sure that they are collected for recycling. Please follow the notes and markings on the packaging.

Disposal of your old device



This product is subject to the European Waste Electrical and Electronic Equipment Directive (WEEE) in its currently valid version. Do not dispose with your normal household waste.

Dispose of this device through an approved waste disposal firm or through your local waste facility. When discarding the device, comply with the rules and regulations that apply in your country. If in doubt, consult your local waste disposal facility.

maTrixx SC-100 DMX LED Effect



Musikhaus Thomann · Hans-Thomann-Straße 1 · 96138 Burgebrach · Germany · www.thomann.de